



Open Innovation Environment in materials characterisation: the example from
H2020 project OYSTER
(Marco Sebastiani – coordinator)

EMMC International Workshop 2019

Session 16 - Innovation hubs: next generation collaboration and services on
marketplaces

Feb. 27th 2019



EC STRATEGY TO SUPPORT MANUFACTURING INDUSTRY

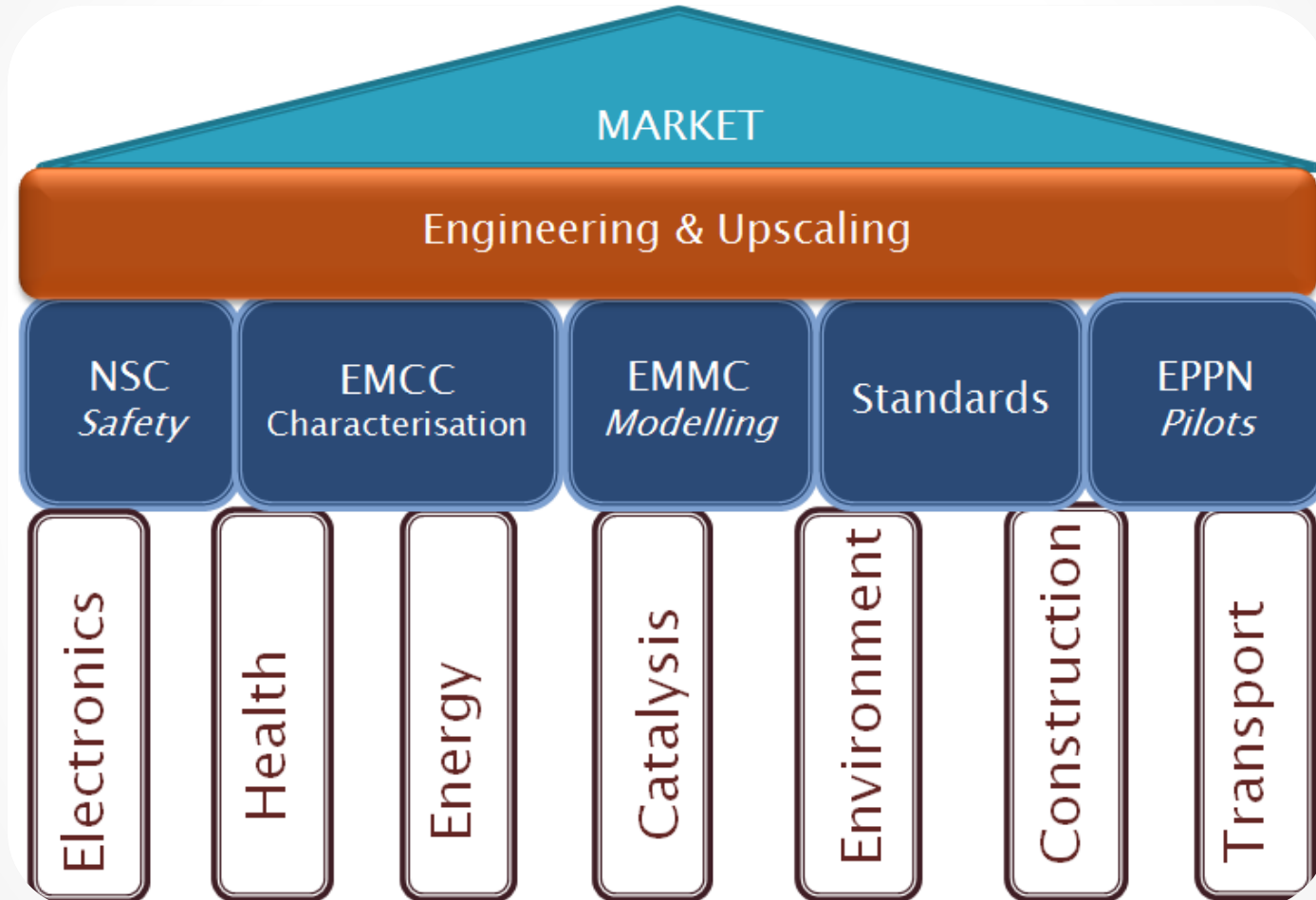

In the triangle of manufacturing, modelling, and experimentation, the projects should develop an open innovation environment for the optimisation of materials, materials behaviour and/or nano-device manufacturing processes, and for the validation of materials models based on experimental characterisation.

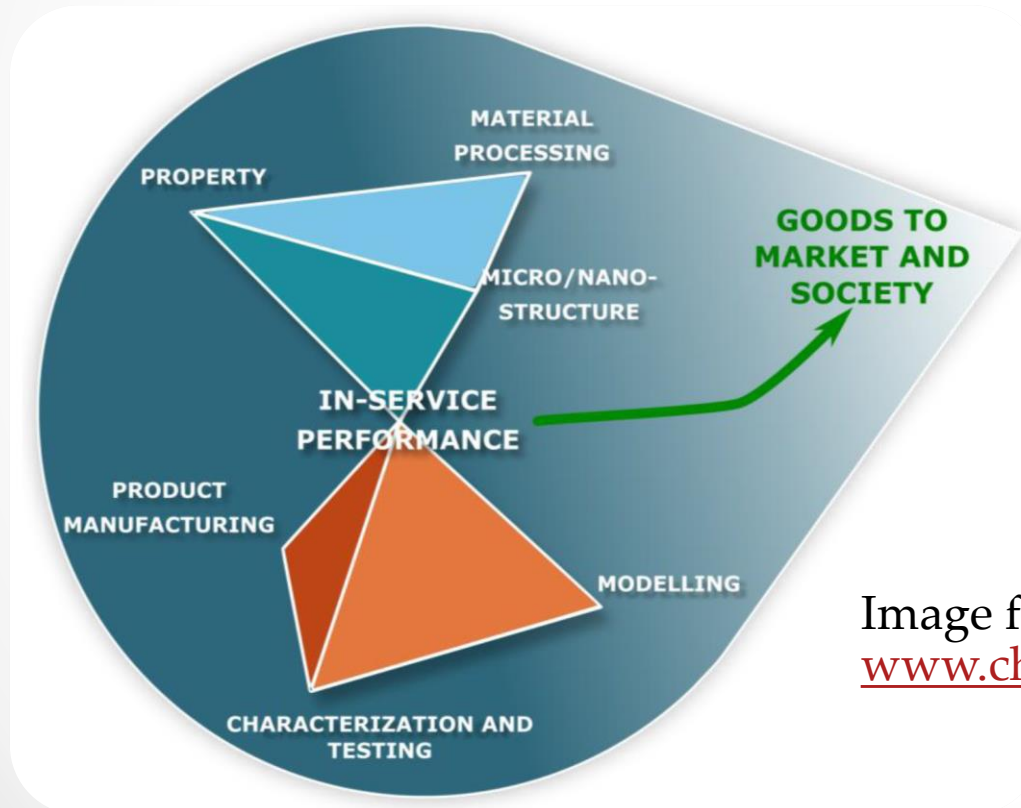
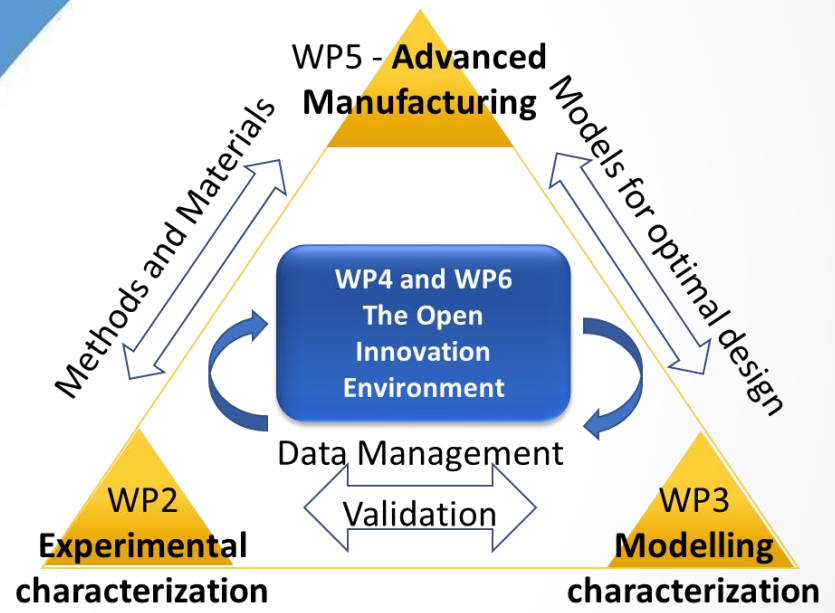
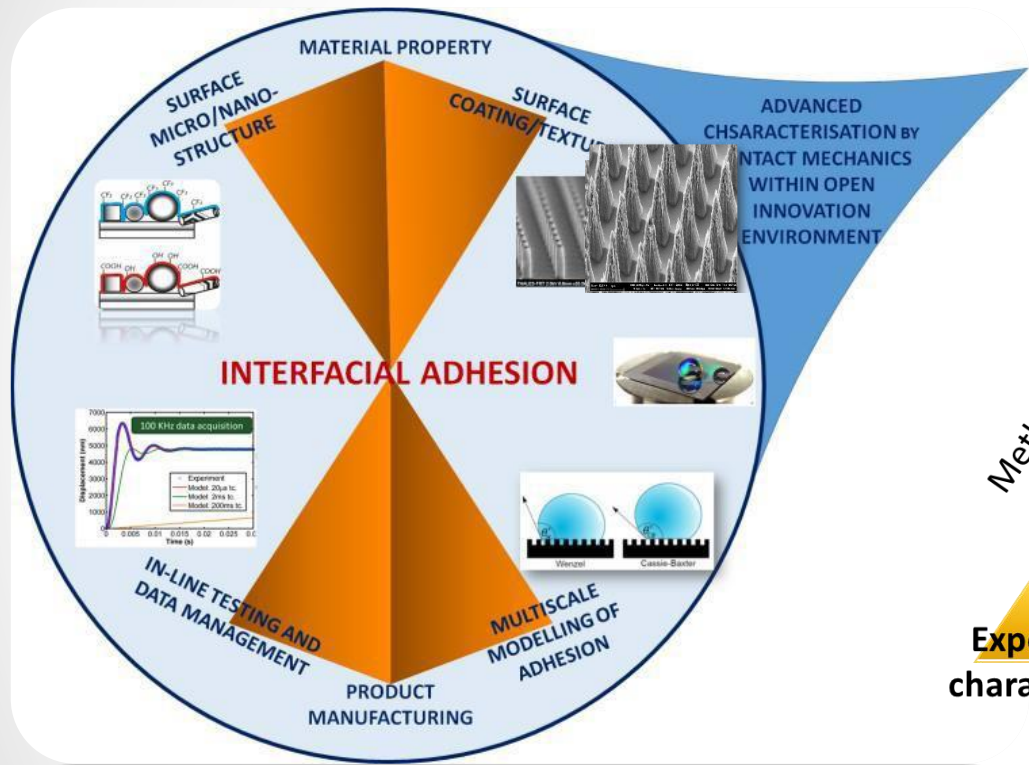
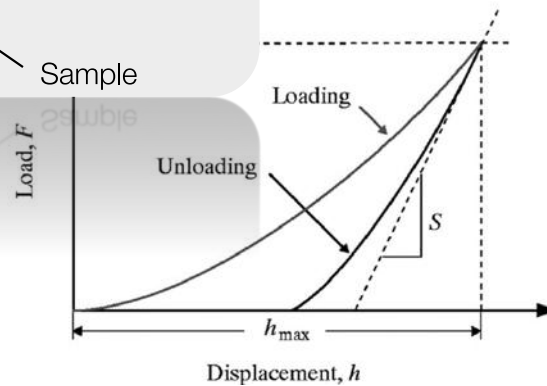
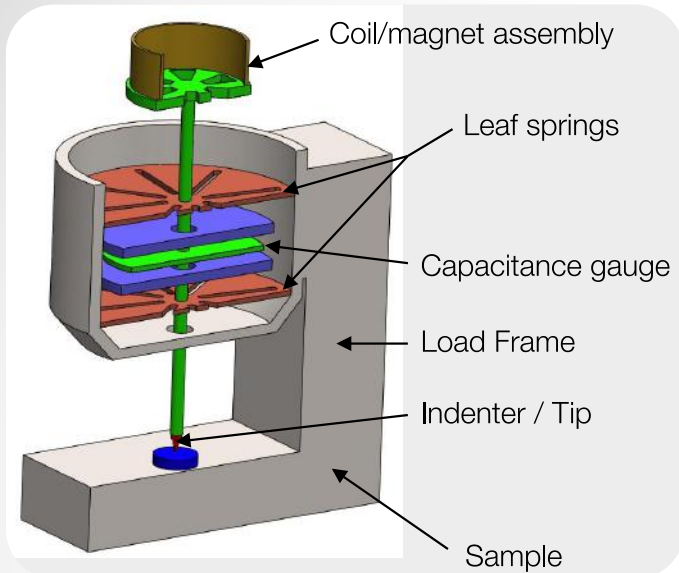

Image from EMCC 2017 roadmap,
www.characterisation.eu



NEXT GENERATION NANOINDENTATION



W.C. Oliver, M.G. Pharr,
JMR, 1992

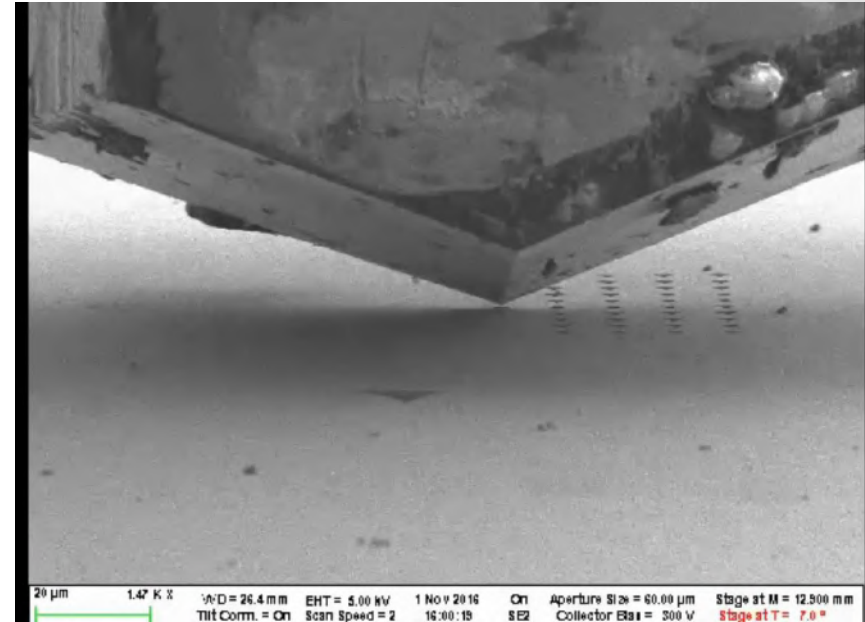

Courtesy of: 

Surface Free Energy by Nanoindentation by High-Frequency (100 kHz) data acquisition nanoindentation experiments.

H2020 – OYSTER WIDER IMPACT

- Self-cleaning properties

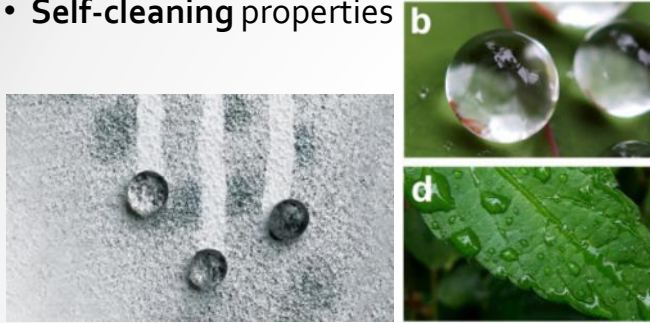

- Improvements of glass performances for optronic devices



- Friction reduction



- Anti-icing performances



- Enhancing of the heat transfer coefficient

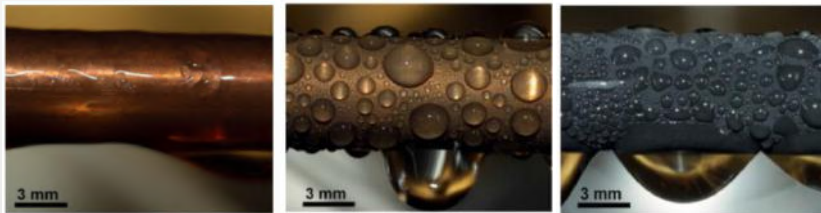

- Improving the contact lens resistance



Zhang, P. et al. *Energy* 82 (2015): 1068-1087.

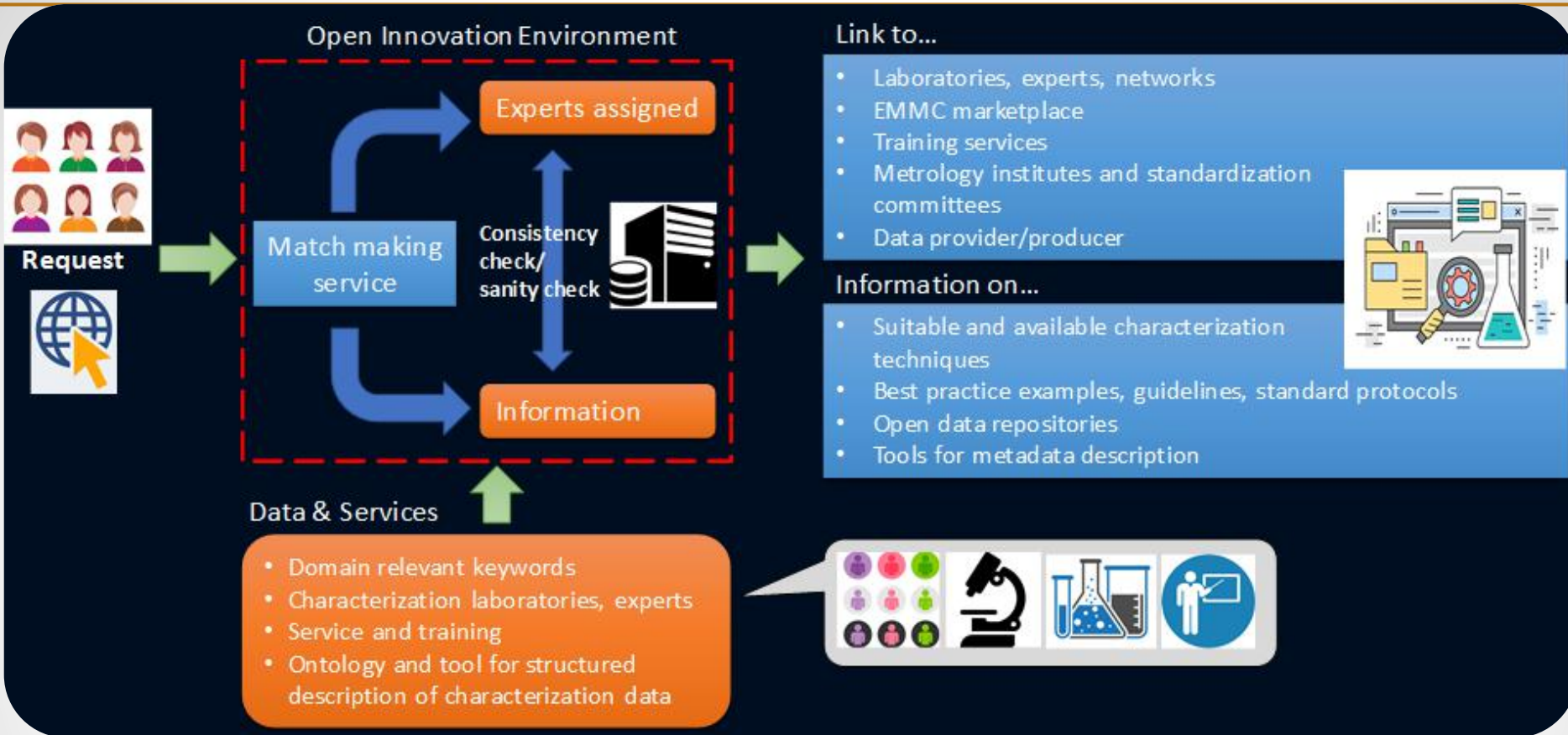

The platform is designed to be fully compatible with the one developed within the MARKETPLACE project.

- Our proposal for a strategy is to pursue the concept of an **Open Characterization Platform** based on a semantic footing and open standards.
- This is basically one step removed from an actual common platform implementation, but provides the **interoperability standards** for it.
- On this basis, **different platform implementation can exist**, but would be highly interoperable if the same standard is used (starting from **CHADA** and **ontology**);

The main step to start this is the development and wide adoption of CHADA

WHERE WE START FROM: THE MODA (EMMC)

Consecutive workflow: linked models

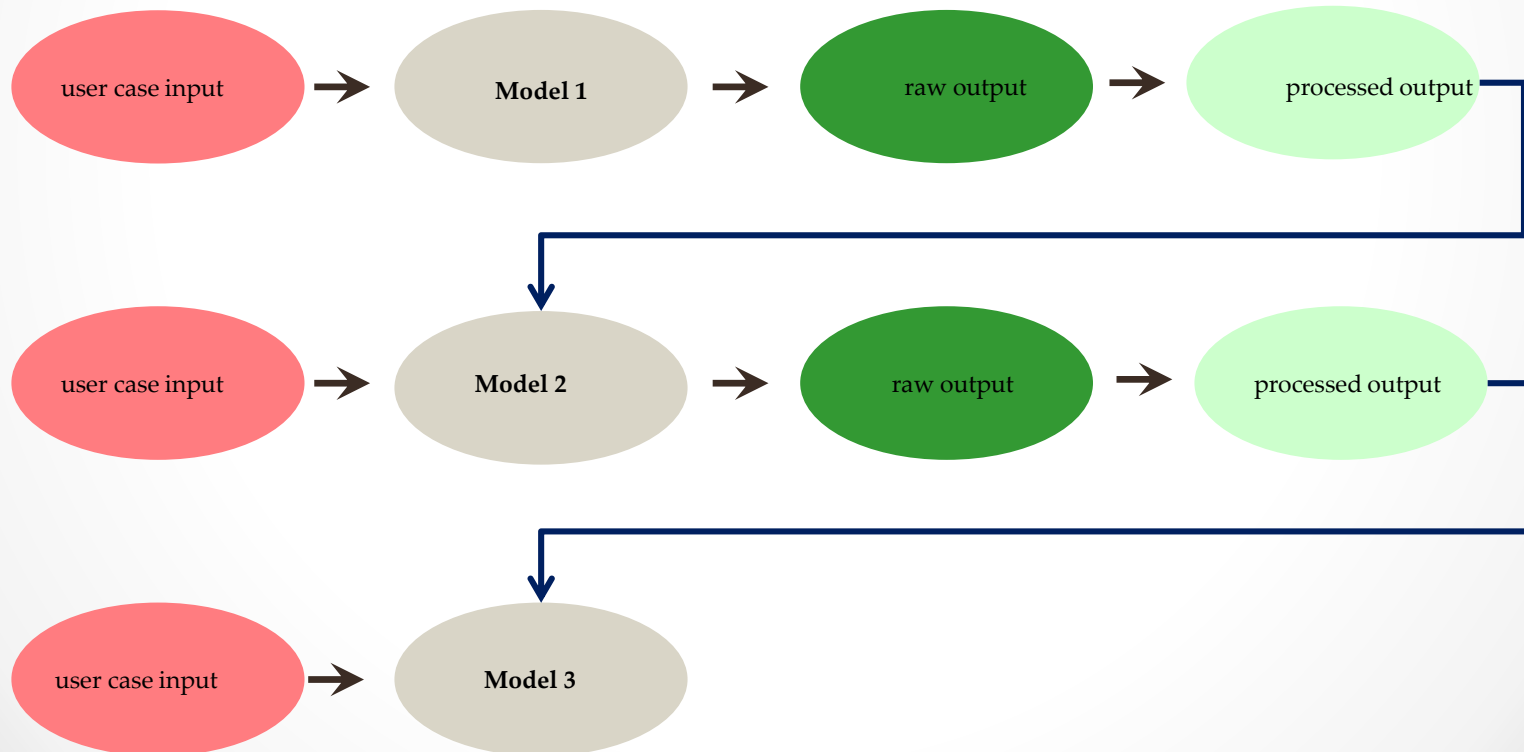

VISUAL REPRESENTATION OF A GENERAL CHARACTERISATION EXPERIMENT

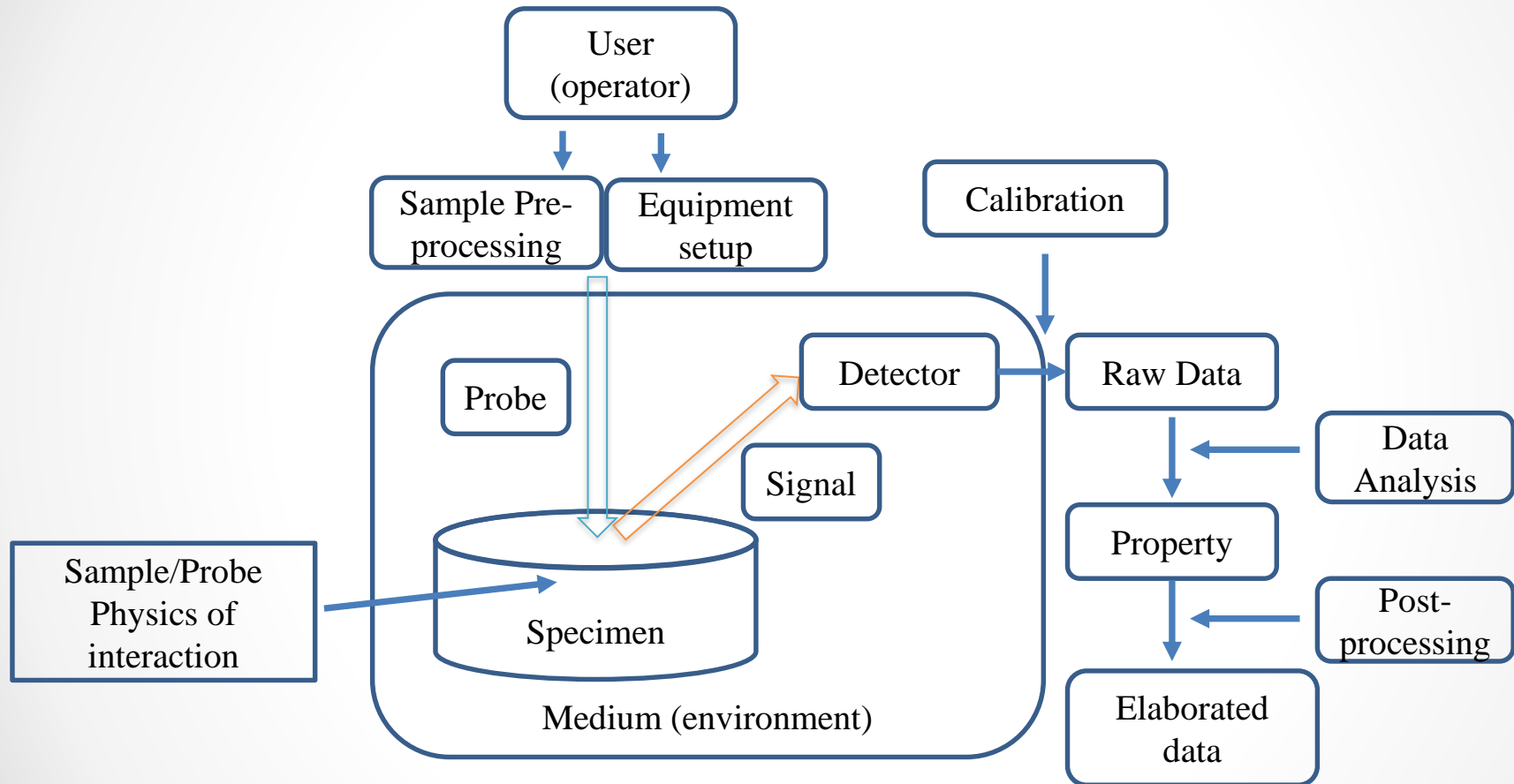

VISUAL REPRESENTATION OF A GENERAL CHARACTERISATION EXP. WITH KEYWORDS (AND COLORS)

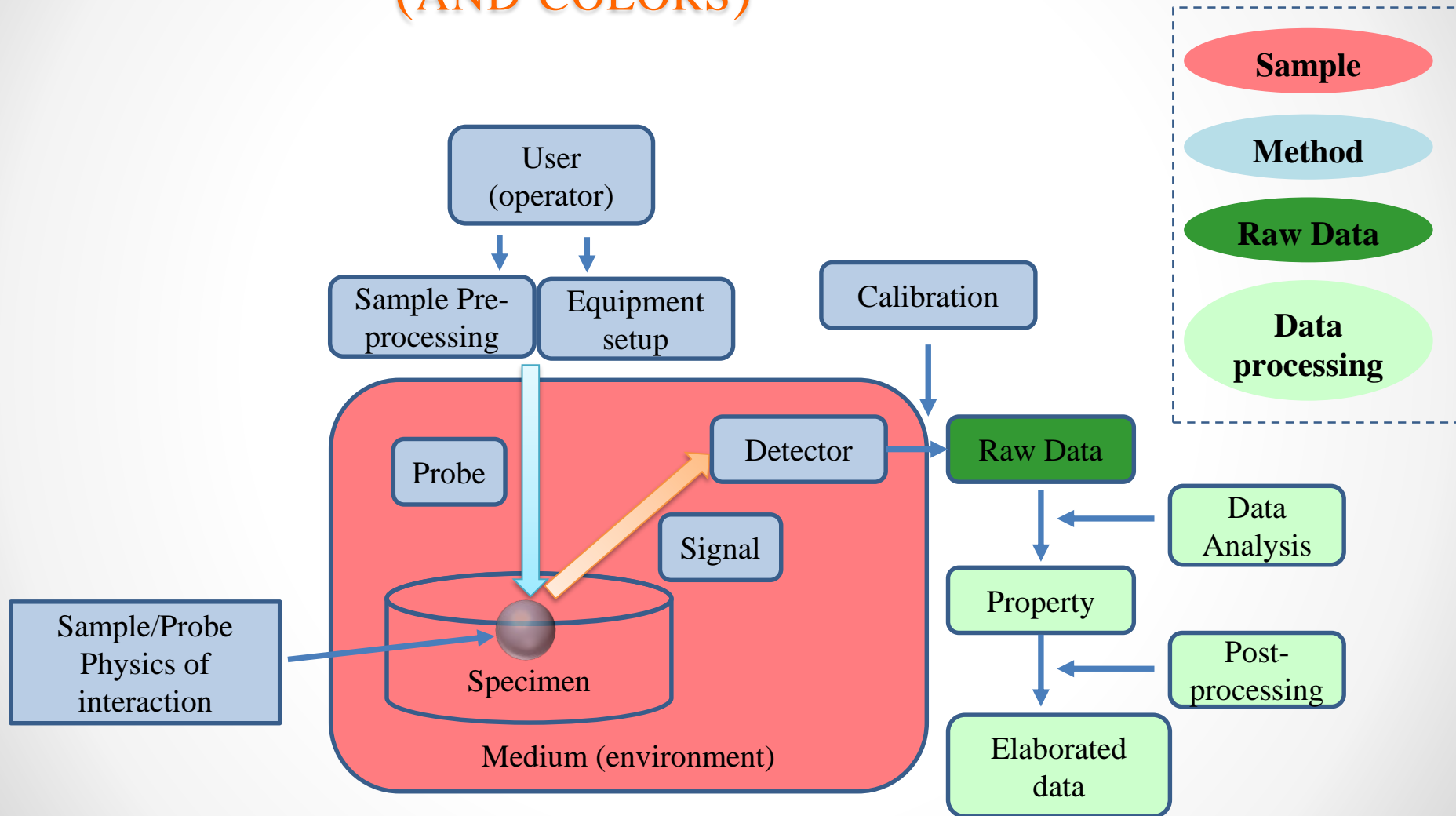

Characterisation method made of a machine calibration process on a reference sample, followed by the actual measurement

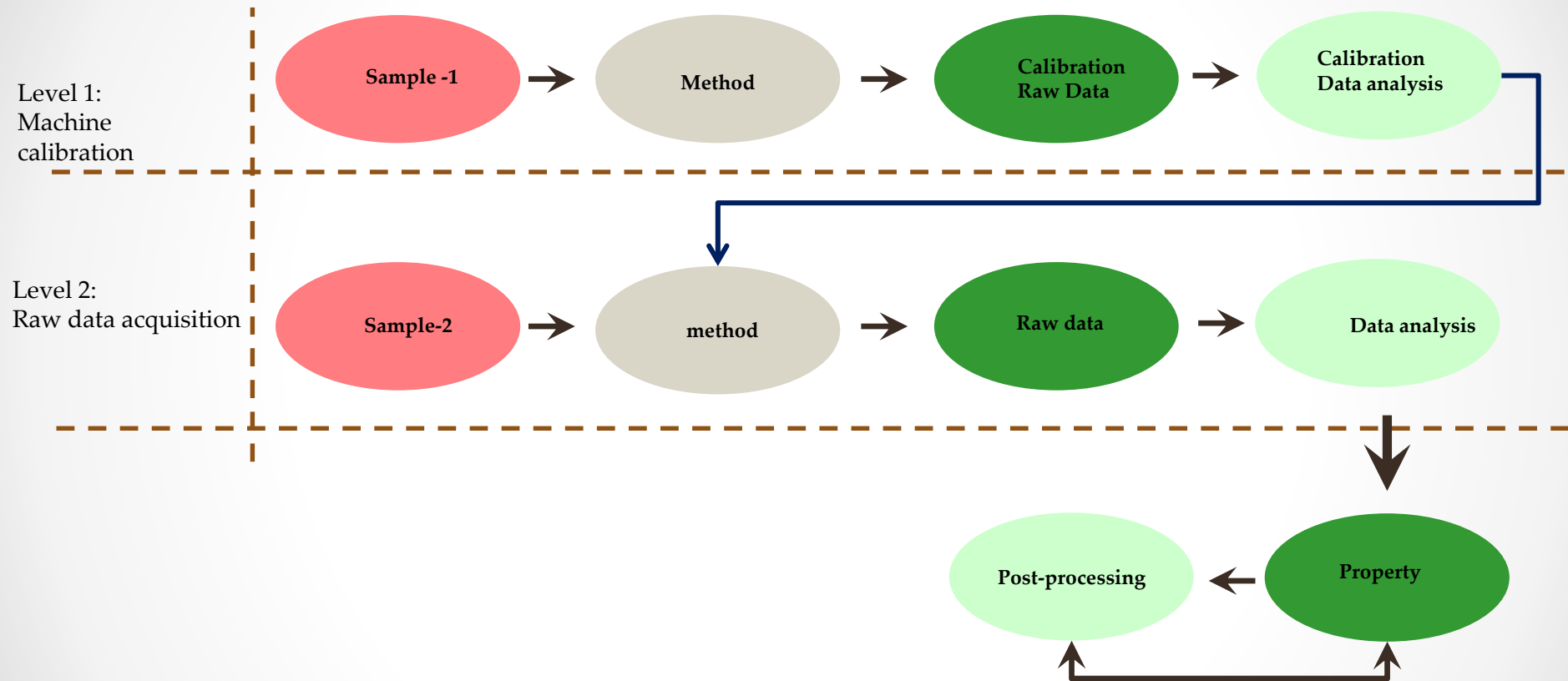

EXAMPLE: Nanoindentation

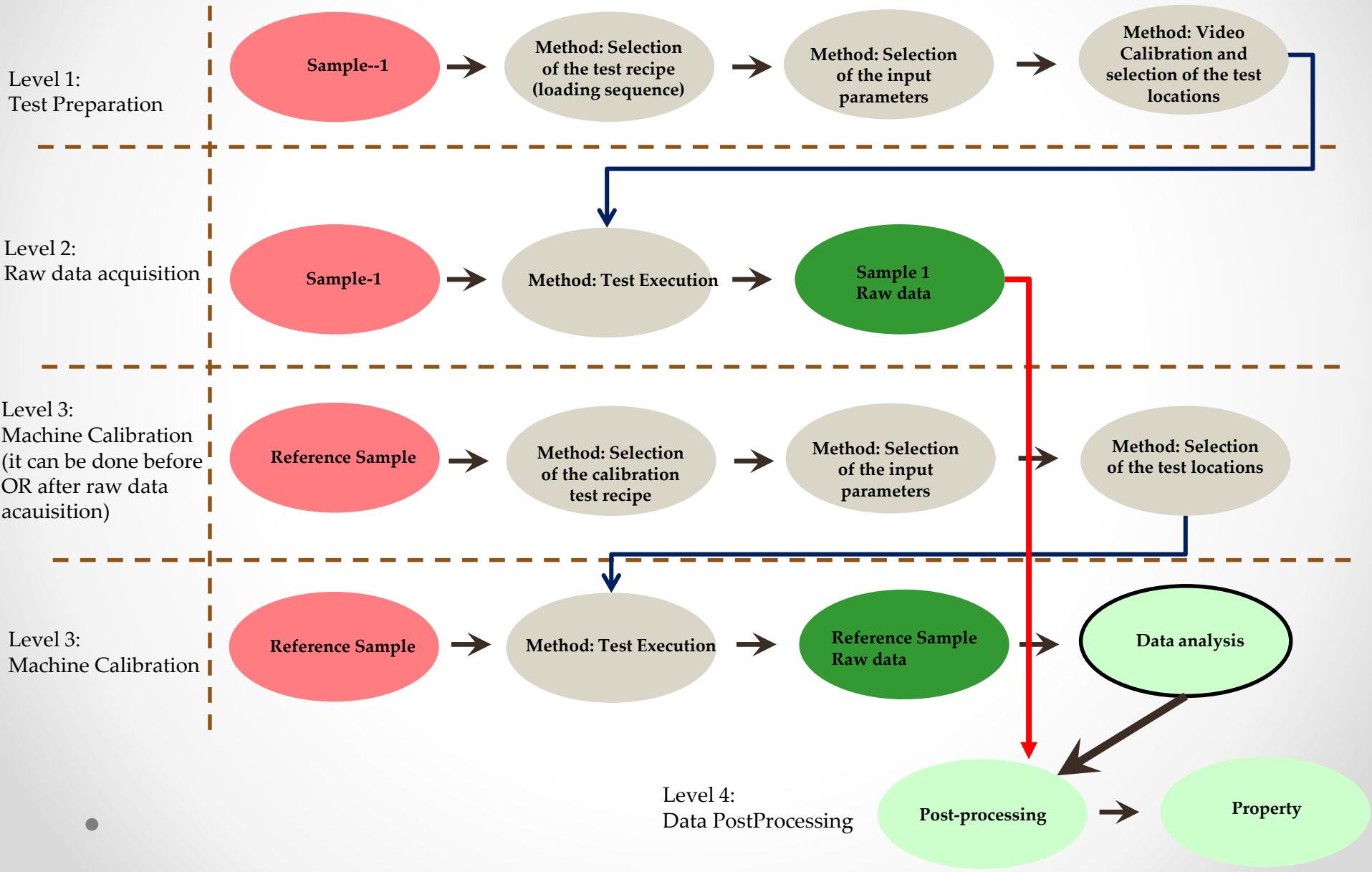

Keyword	Description
User (operator)	Human Operator (different levels of automation are available)
User case (sample specifications)	Sample dimensions (1 inch diam. – 5 mm thick.). Surface flat and polished. Sample embedding on sample-holder (hot glue or acrylic glue). Optical sample surface alignment with reference sample (SiO ₂) surface.
Specimen	Bulk material, coatings, heterogeneous materials, bio-material.
Medium (environment)	Equipment Box: Air, Temperature, Pressure, Humidity, Noise, Vibrations (Acoustic or mechanical).
Sample/Probe Physics of interaction	Detection of the surface by the tip (stiffness triggering value based) – Penetration of the tip inside the sample using a prescribed load function – Hold of the maximum load (or the load for the prescribed depth – unloading of the tip by steps – tip removal from the sample.
Equipment setup	Optical alignment of the sample. Method selection and Input parameters for the test (Sample Poisson's Ratio, Prescribed Depth or Load, number of tests, locations of the tests, Engage options).
Calibration	Standard CSM tests on reference sample.
Probe	Selected Tip for the test (Berkovich, Cube Corner, Flat Punch..).
Detector	Electronic controllers and capacitive gauges.
Signal	Electrical current in a coil -> Force (Load)
Data Analysis	Check of the surface detection, check of the Load vs depth quadratic curve trend, check of the slope of the unloading curve, removal of the not significative tests.

Keyword	Description
Raw Data	Hardware and software channels graphs (Raw Load, Raw displacement, Stiffness, Load, Depth...).
Raw Data Analysis	Application of the Oliver-Pharr method (or other data analysis methods)
Post-processing	Raw data calibration using tests on reference sample, check of the results (see data analysis), Selection of the load (or depth) range to evaluate the mechanical properties, Graphs or hystograms of interest.
Properties (elaborated data)	Elastic Modulus, Hardness, Yeld Stress, Residual Stress, Creep parameters, Fracture toughness, mechanical maps, etc.

- Modelling and Characterisation platforms should interact deeply and in a structured way;
- Quality of **match making services** can be improved by using only **EMMC and EMCC experts**, as qualified through ORCID/researchgate (or similar) services;
- **Sharing of usable MODA and CHADA** could become the MAIN added value for such platforms;
- Adding a DOI to MODA and CHADA can be the key for spreading of such approaches through CITATION in the experimental section of papers.

- **Data sharing and exploitation:** tools already exist in the community – modelling/characterisation platforms should be used mostly for sharing high-quality reference data on specific models/methods;
- The most convincing approach for data sharing/linking/hosting in common platform is to build a shared architecture for modelling (or characterisation) data;

- **Integration between Modelling and characterisation hubs Should be a main goal for Eu Coordinated actions;**
- Different (but harmonised) Data description architectures and ontologies can be developed and validated on real industrial case studies;



This project has received funding from the European Union's Horizon research and innovation programme under grant agreement No 760827.



THANK  YOU!

Contact details:

Seba@uniroma3.it